

## Dismantling Information of Hisense TV

The document is intended for use by end-of-life recyclers. It provides the basic instructions for the disassembly of Hisense products to remove components and materials requiring selective.

### Manufacturer and Contact Information

Manufacturer Information	
Name	Hisense Visual Technology Co. ,Ltd.
Address	No.218 Qingwangang Road, Economy &Technology Development Zone.Qingdao.China
Importer Information	
Name	Gorenje gospodinjski aparati, d.o.o.
Address	Partizanska cesta 12, 3320 Velenje Slovenija

### Product information

Type of product	LED TV
Model name	55A8#### Which has same conceptual design and dismantling process

All of the components of TV indicated in point 1 of Annex VII of Directive 2012/19/EU on WEEE or in Article 11 of Directive

2006/66/EC of the European Parliament and of the Council(1) on batteries and accumulators and waste batteries and accumulators.

## Contents

### 1. Tool Required

### 2. Product Dismantling Process

#### 1 Tools Required

List the type that would typically be used to disassemble the product to a point where components and materials requiring.

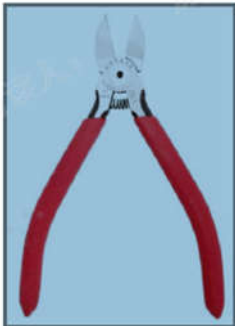
Tool Description	Tool information
Screw driver	
Nipper	

#### 2 Product Dismantling Process

##### 1. Batteries

Batteries can easily be removed from the remote control once the

backcover of the remote control has been removed.

①

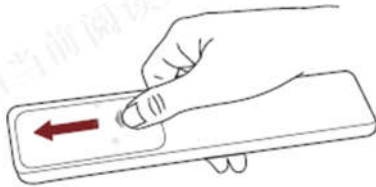

②

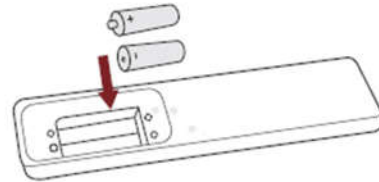

## 2. PCB and LCD Module

The back cover of the display can easily be removed by screw driver and hand.

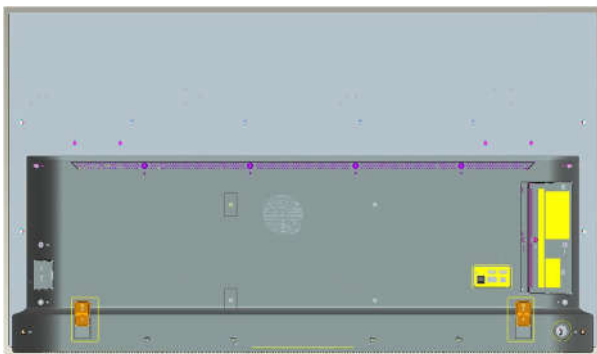

Once removed, this will expose the PCBs Units, which can now be easily removed with hand and screw driver, remove the WIFI module, key pad and IR .



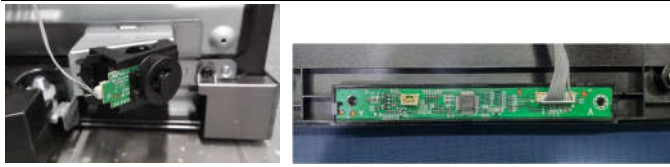

You can refer to the exploded view to disassemble easier.

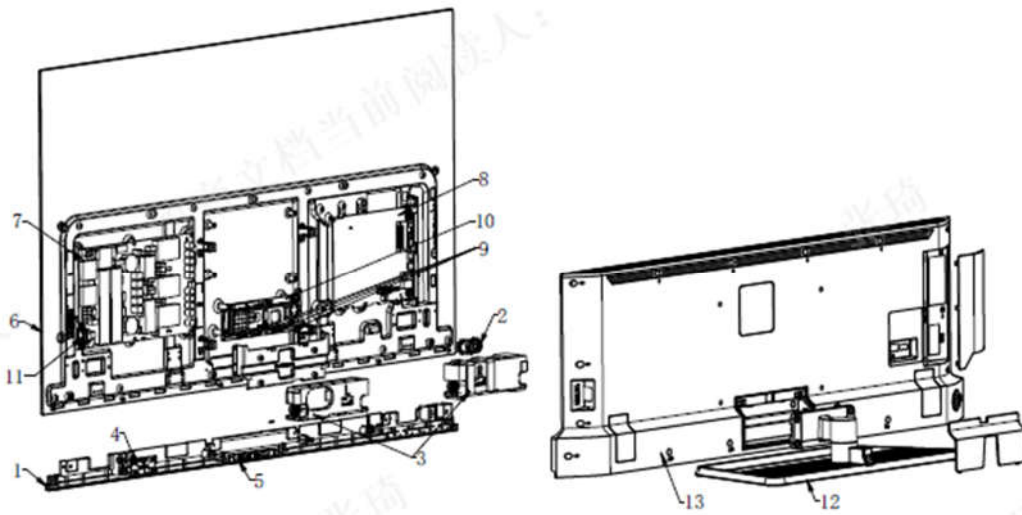

### 3.Capacitors>25mm

Capacitors>25mm are located in the power supply units and can be removed by nipper.

